



# COST

## European Network on New Sensing Technologies for Air Pollution Control and Environmental Sustainability - *EuNetAir* COST Action TD1105

**WGs and MC Meeting at Rome, 4-6 December 2012**

Action Start date: 01/07/2012 - Action End date: 30/06/2016

Year: 2012-2013 (*Starting Action*)



UNIVERSITY of OULU  
OULUN YLIOPISTO



Linköping University  
INSTITUTE OF TECHNOLOGY

**Presenter: Anita Lloyd Spetz, (Vice-Chair)**  
University of Oulu / Finland  
and Linköping University / Sweden

# Personal Particle Detectors

Cheap, easy to operate, reliable detectors are needed that detect particles according to:

- Size
- Number
- Mass
- Shape
- Content

Since all these parameters influence if the particles are toxic or not

# Particle detectors based on cantilever devices

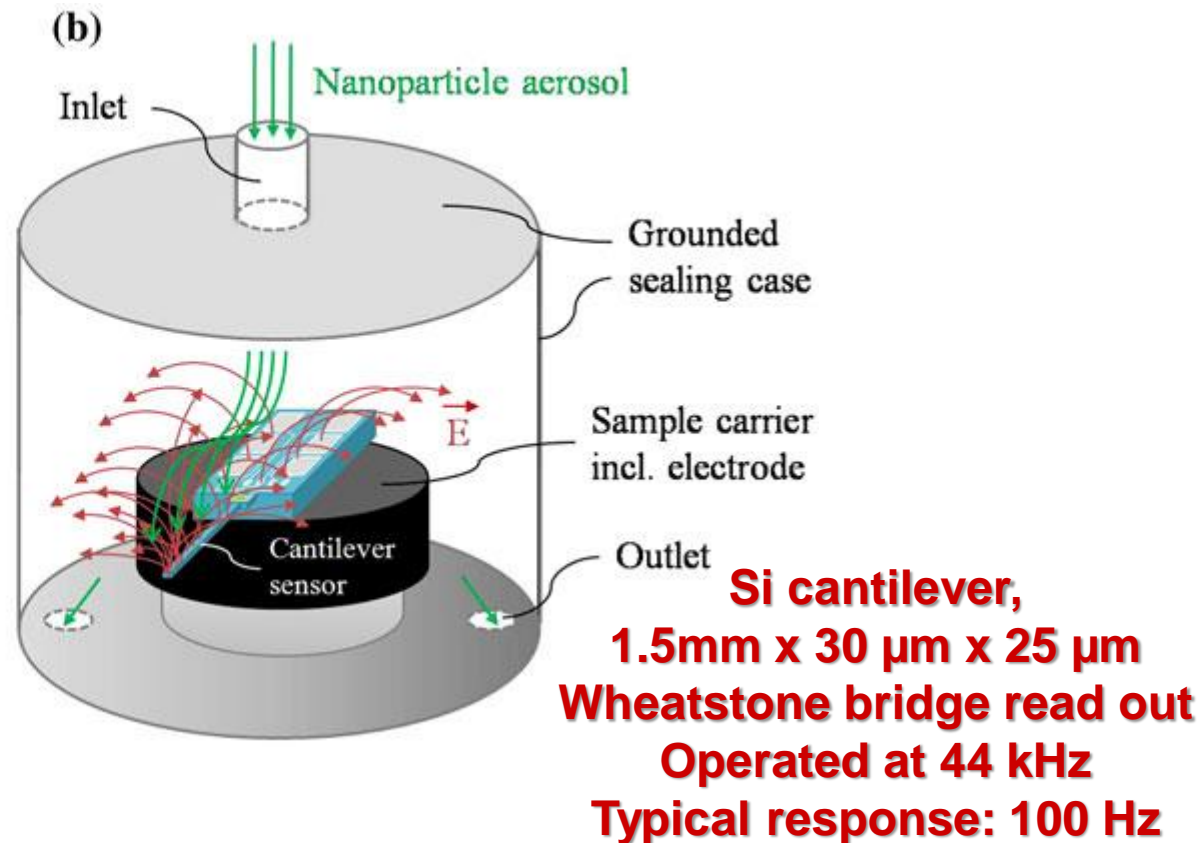
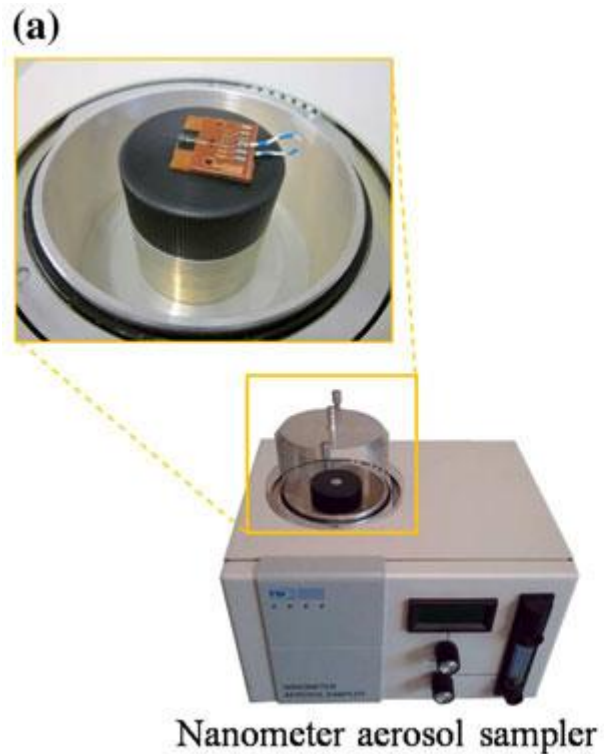

**Particles are injected and accelerated towards the sensor by an electric field (-5kV)**

# Particle detectors based on cantilever devices

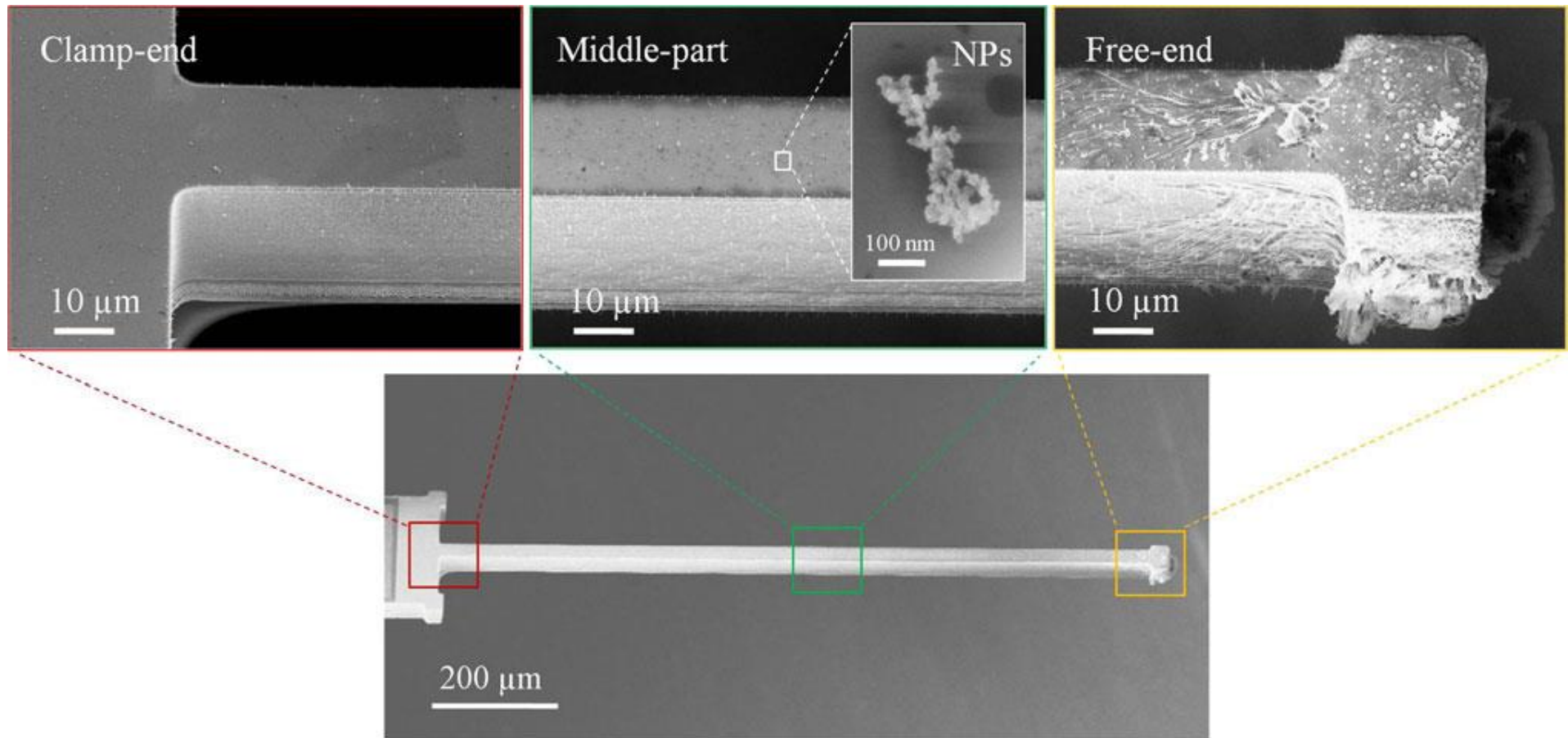

## FE-SEM pictures of the cantilever with particles

# Soot sensor based on thermophoresis

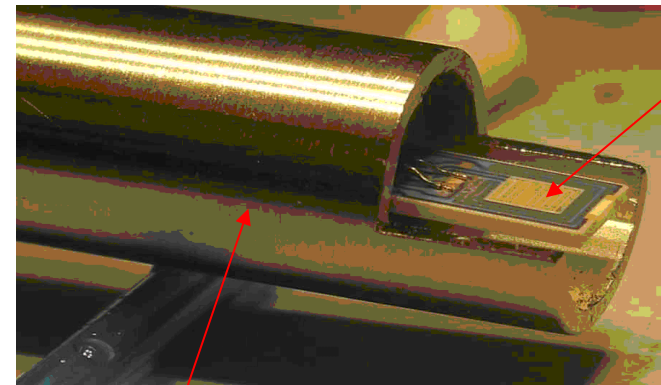

**Soot  
sensor  
surface**

**Thermos**



**MD13 Heavy duty truck engine**



# Soot sensing based on thermophoresis

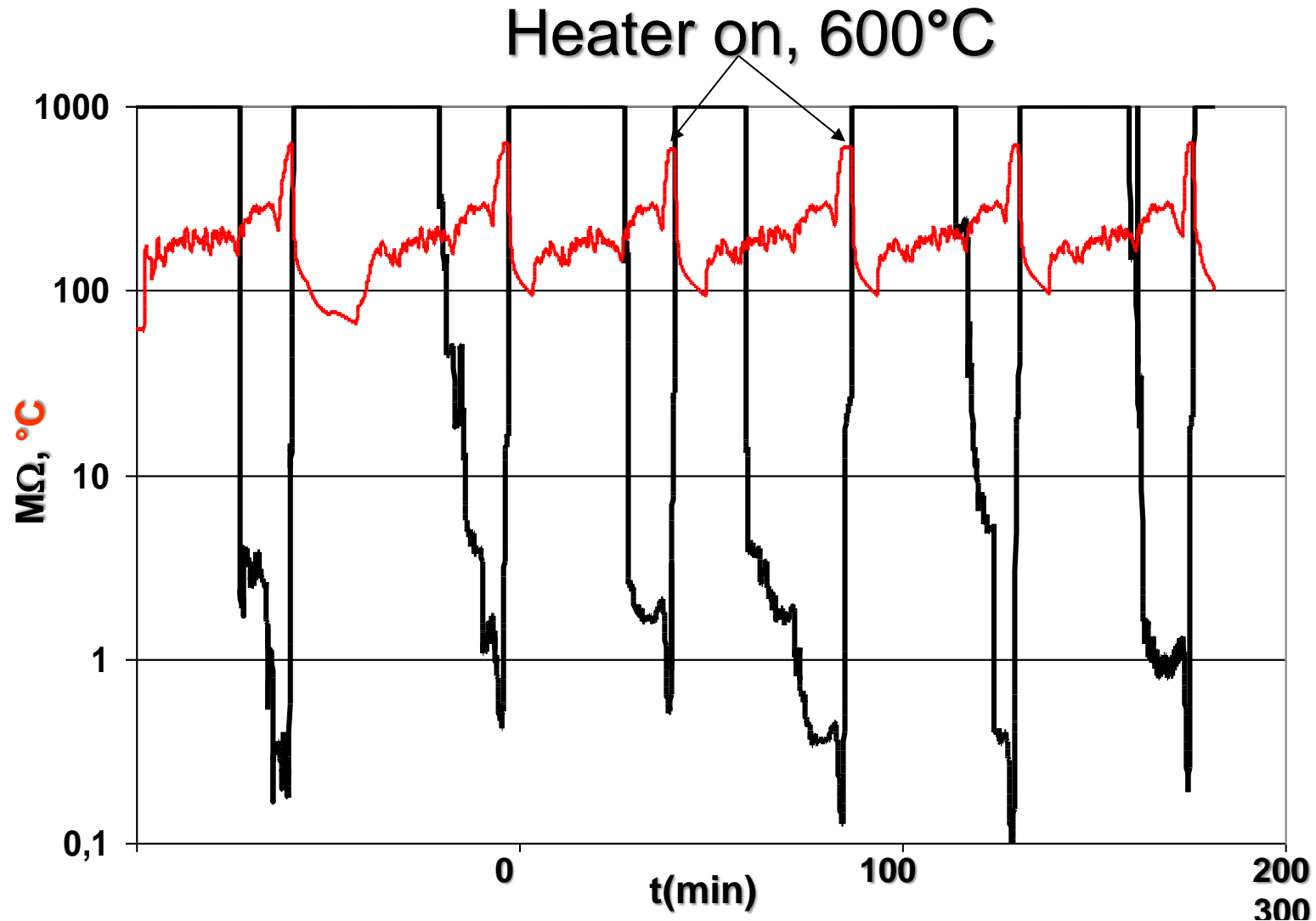

Exhaust  
gas  
200°C

Sensor  
160°C

Robert Bjorklund  
Ann Grant

6 World Harmonized Transient Cycles  
30 min/cycle, 18 min response time, 1370 mg/cycle, 40 mg/kWh)

# Three soot concentrations & Sensor temperature effect

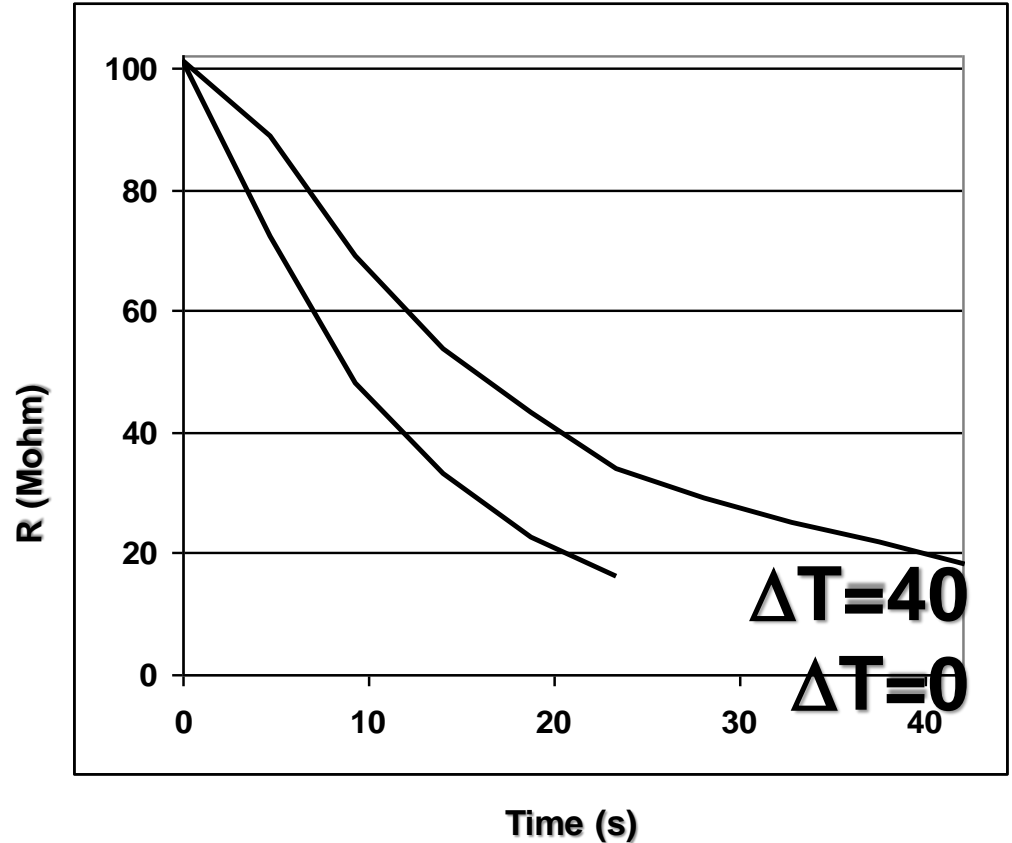
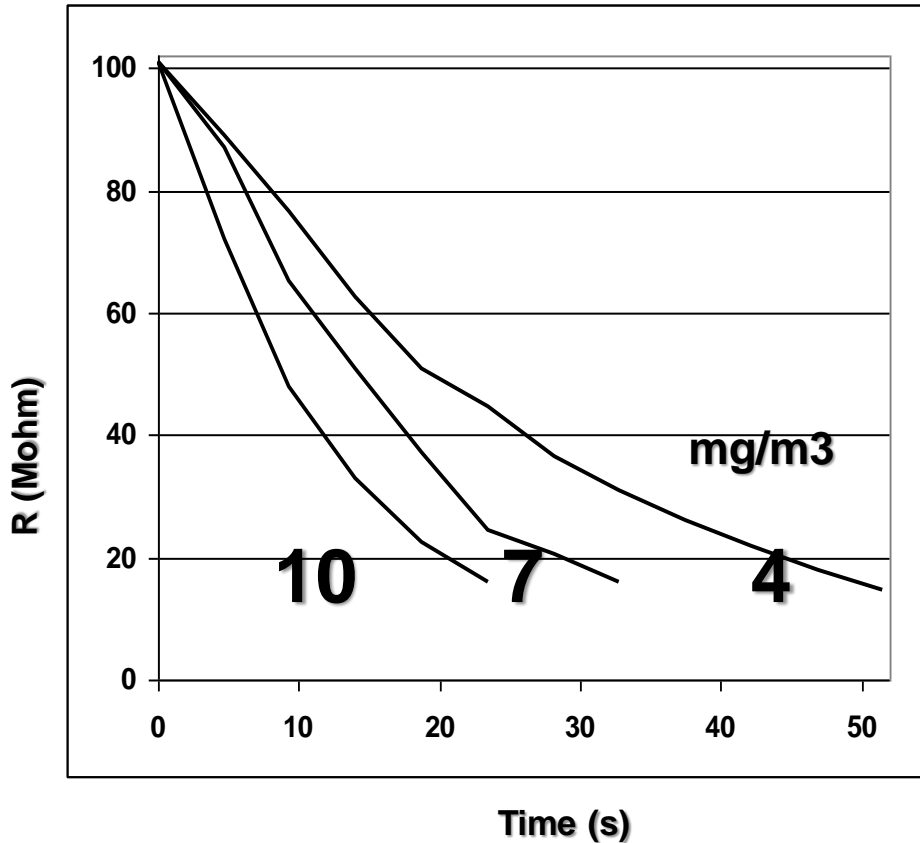

Soot concentration measured by a Cambustion DMS 500 particle size spectral analyzer

# Particle detectors based on interdigital electrodes

**Resistivity changes** are measured between the electrodes for detection of concentration of particles

**Impedance spectroscopy** can be used to differentiate between size, shape and to some extent kind of particles.

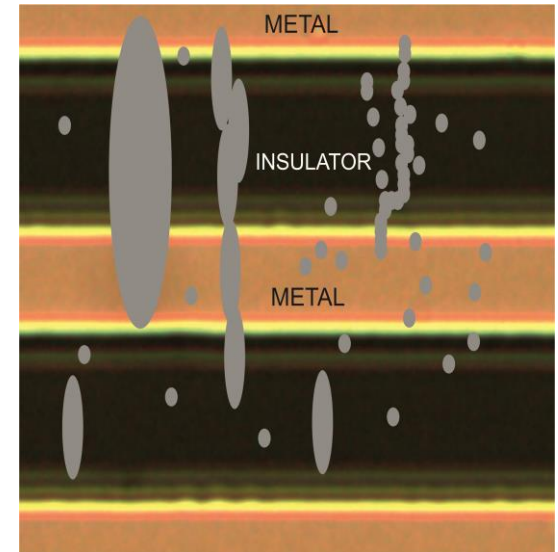
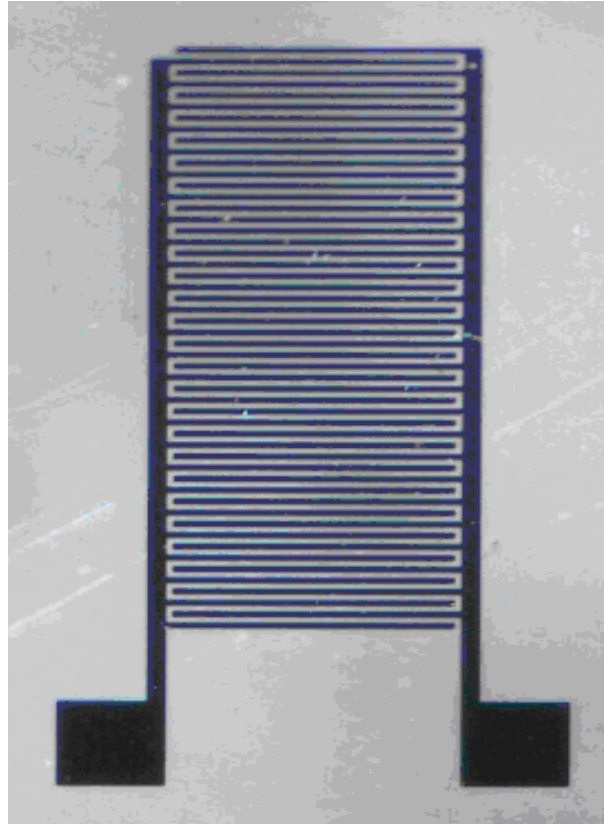



# Impedance spectra of particles from steel plant and CNTs

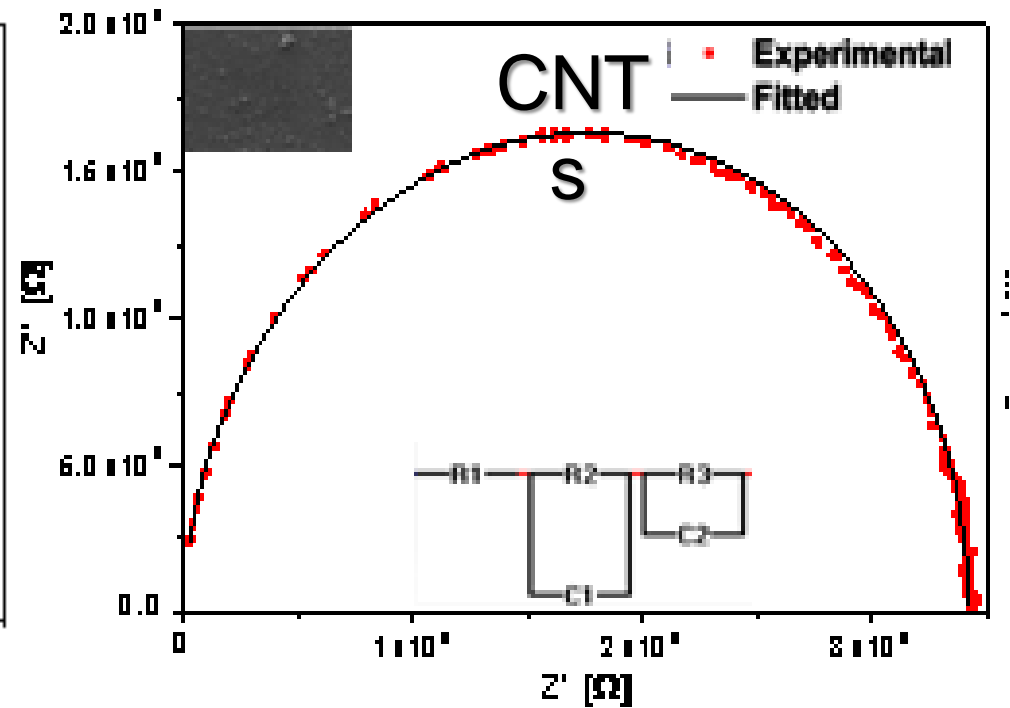
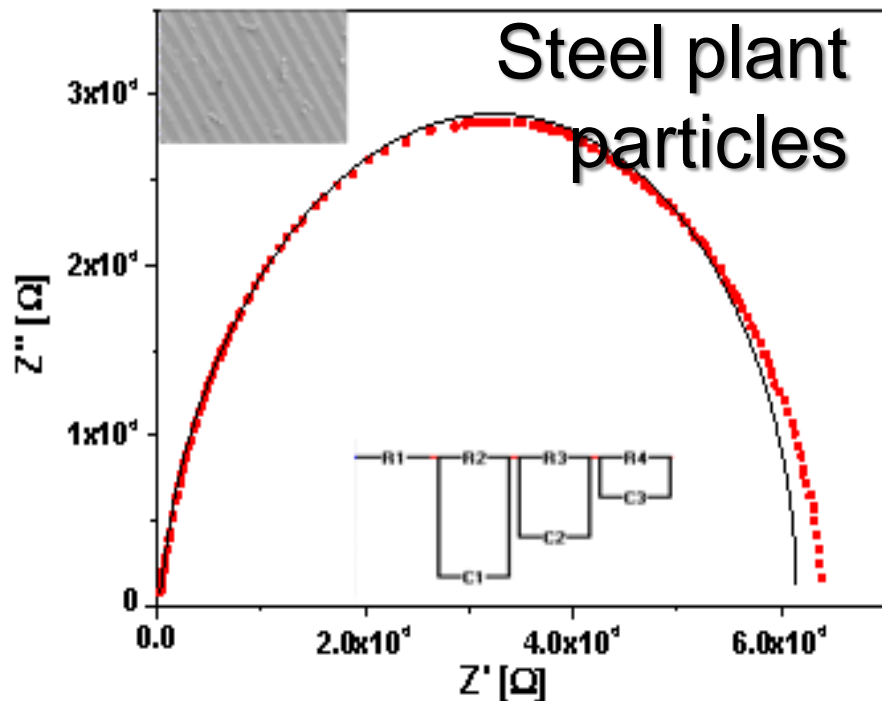

Joni Huotari

Impedance spectra for detection of concentration, size, eventually content with potential for on-line measurements

# Detection of particle content

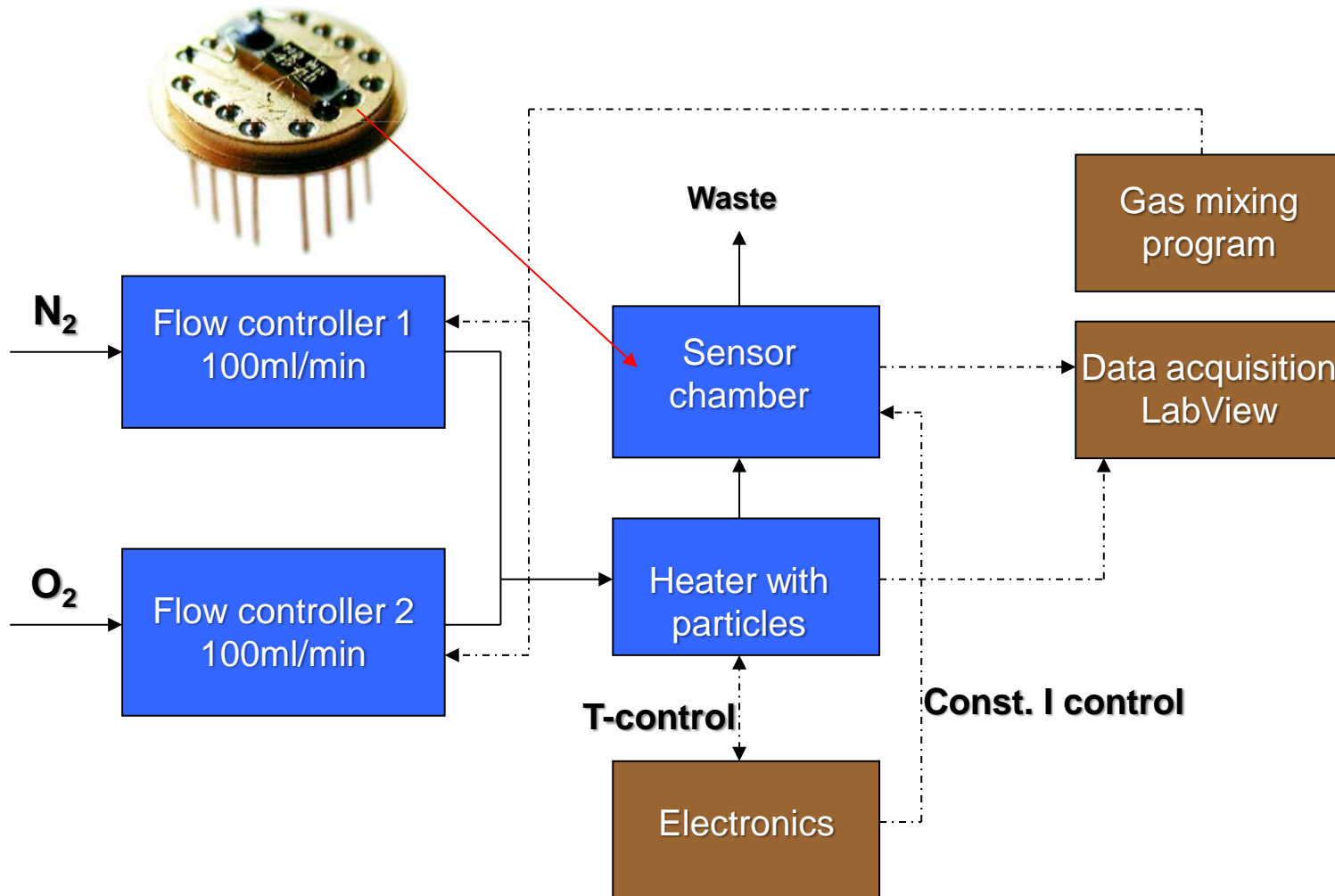

Heating of particles and detection of emissions with gas sensors. Collaboration with Saarland University, Germany

# Detection of particle content

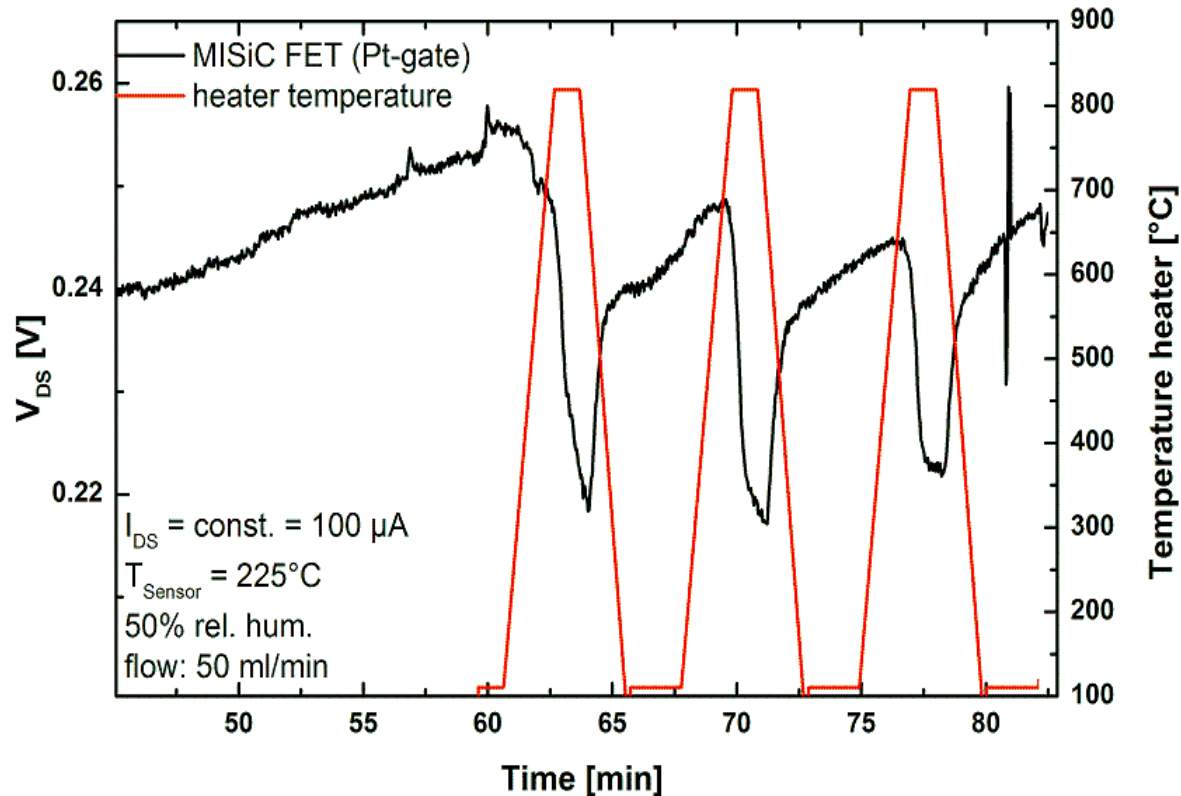

Christian Bur  
Saarland Univ. &  
Linköping Univ

**Detection of ammonia containing fly ash particles.  
Particles are heated repeatedly from RT to 860°C.  
A small gas flow brings the emissions to SiC-FET sensors.**

# Personal Particle Detectors

The sensor system should:

- **Collect particles** (thermophoresis, applied voltage, magnetism)
- **Sort according to size** (impedance spectroscopy)
- **Give the number of particles** (impedance spectroscopy)
- **Weigh** (resonators)
- **Define the shape**
- **Detect the content of the particles** (heat and detect emissions by gas sensor array)





# Research Facilities

- Particle generator and detector (under construction)
- Advanced LTCC packaging technology
- Sensor arrays, SiC-FET and MOS sensors, for detection of emissions from particles
- Gas mixing system and electronics for sensor measurements, also temperature and bias cycling
- Environmental mass spectrometer
- PLD system, sputter system and thermal evaporation
- Environmental Kelvin probe and STM, SEM, TEM, XPS, XRD...

# Suggested **Priorities** for future research to Action WGs/SIGs General Assembly

- **(2 slides)**
- **Research directions as WGs PRIORITIES for Action TD1105:**
- [Suggest briefly the PRIORITIES for research to be carried out in the Action for future activities.]
- [Highlight the *Innovation* of your suggested PRIORITIES]
- **Please, organize these 1-2 slides AFTER DISCUSSION of your WG or SIG Meeting on 5 December at Rome taking into account various contributions from WG/SIG partners. This Presentation must be given by the WG or SIG Leader to related Action General Assembly.**





# Scientific context and objectives in the Action

- **Background:**
- Development of a portable cheap particle detector for environmental monitoring
- **MoU objectives:**
  - WG 1-4 (materials, devices, environmental measurements and air pollution modeling, protocols and standards)
  - SIG 2-4 (Smart gas and particle sensors for urban air monitoring, coupling between pollutants and transducer, revised Air Quality Directives)



# Current research activities of the Partner (1/2)

**Ongoing research topics** : Development of

- Impedance spectroscopy using IDEs for detection of concentration, size and eventually nature of particles
- Suitable packaging for collection of particles and detection of size, concentration, content of particles
- Method for detection of content of particles based on heating of particles and detection of emissions by FETs and MOS sensors
- MOS sensors based on PLD, pulsed laser deposition, like vanadium oxide and tungsten oxide
- SiC-FET sensors for e.g. H<sub>2</sub>, NH<sub>3</sub>, CO, HC, SO<sub>2</sub>, H<sub>2</sub>S, VOC (methanol)



# Suggested **Priorities** for future research

**Research directions as PRIORITIES:** Development of

- Portable particle detector (collaboration with Gardner, Resonators for detection of mass)
- Method for measuring content of particles
- FET and MOS sensors with improved selectivity and sensitivity using smart sensing and data evaluation (collaboration Linköping – Oulu and Saarland Universities)
- FET and MOS sensors for measuring VOCs

**Innovations:**

- A portable cheap particle detector which measures also content of particles does not exist today

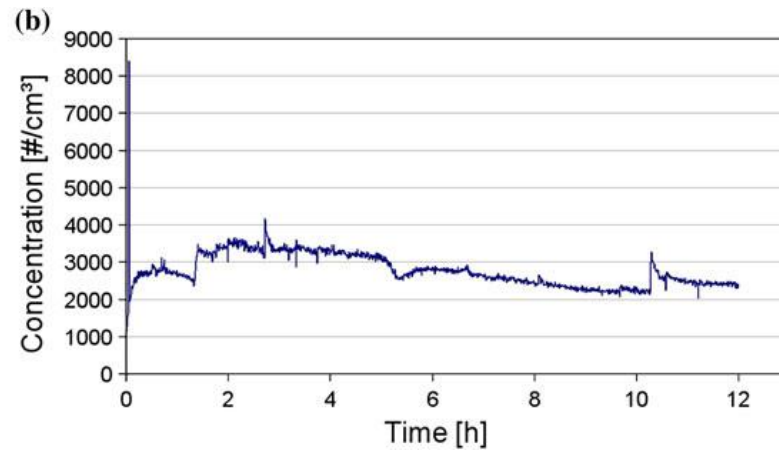
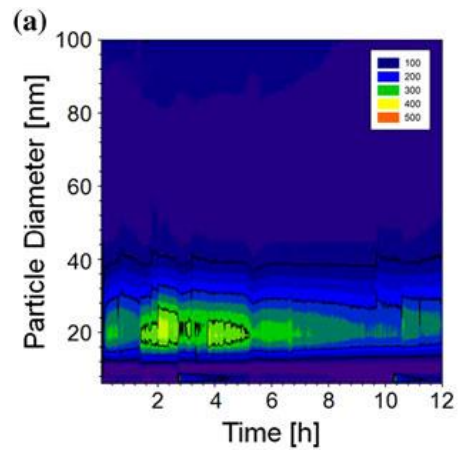
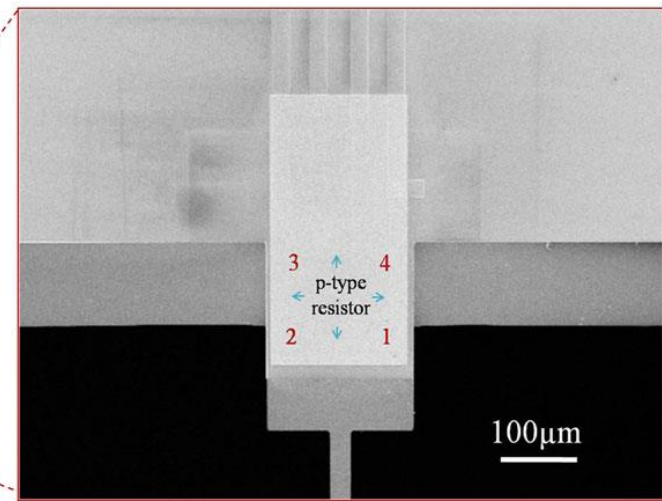
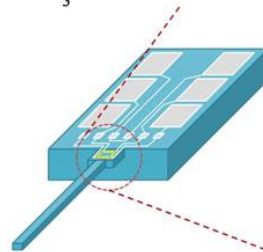
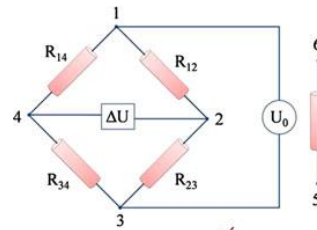
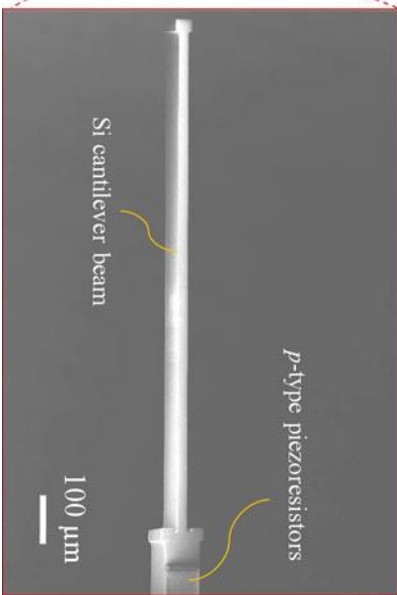
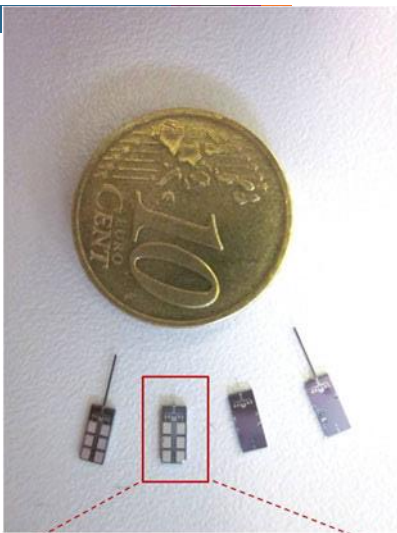

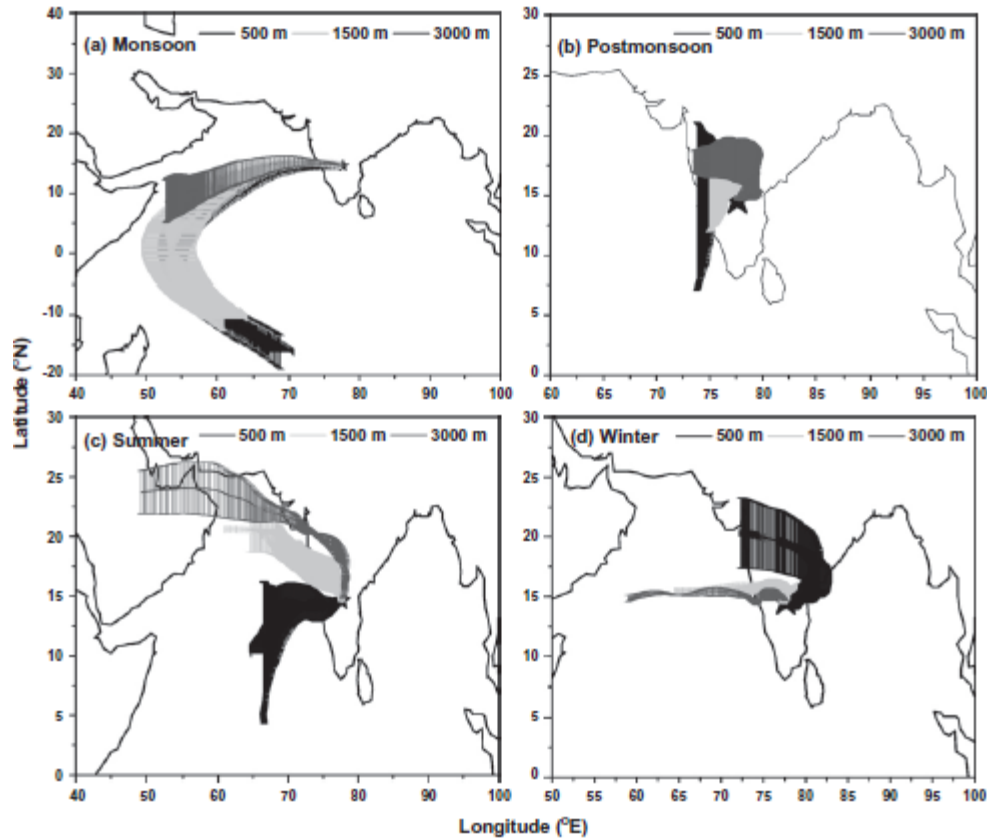

# Particle detectors commercial devices



**DEKATI ELPI (Electrical Low Pressure Impactor (6 nm – 10 µm))**



**Nano-ID™ NPS500 based on DMA (Differential Mobility Analyzer) technology, portable particle measurement device (5-500nm)**

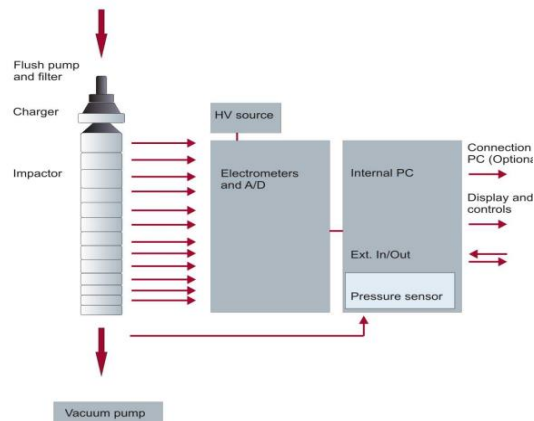



# Background Particle detectors

The air that we breathe is chock-full of particles called aerosols. These tiny liquid or solid particles come from hundreds of sources including trees, volcanoes, cars, trucks and wood fires. The small particles influence cloud formation and rainfall, and affect climate and human health. In the United States each year, 50,000 premature deaths from heart and lung disease are attributable to excess concentrations of aerosols, especially particles less than 2.5 micrometers in diameter.

<http://fineparticleforum.com/?q=node/786> (Fine Particle Forum, Finland)

<http://www.cmu.edu/mcs/news/pressreleases/2012/0808-pinetreeemissions-donahue.html> (Carnegie Mellon University, USA)